



**Ref:435717,435807,435855,435887,435929,435950,
435992,437121,437188,442023,533300,533340,
533339**

IMPORTANT, NOTICE À CONSERVER POUR TOUTE RÉFÉRENCE ULTÉRIEURE : VEUILLEZ LIRE ATTENTIVEMENT LES INSTRUCTIONS.

À monter soi-même. Positionner de manière stable sur un sol plan. Charge maximale conseillée : 100kg. Vérifier que les fixations soient bien en place avant de vous asseoir. Vérifier régulièrement les fixations. Nous déclinons toute responsabilité en cas de mauvaise utilisation, défaut de montage, ou intempéries.

Classe d'utilisation : domestique.

IMPORTANT, RETAIN FOR FUTURE REFERENCE: READ CAREFULLY.

Product to be assembled / self-assembly. Position in a stable way on a flat ground. Maximum recommended load: 100kg. Check that the fastening devices are correctly in place before sitting down. Check the fastening devices regularly. We decline all responsibility in the event of incorrect use, incorrect assembly, or adverse weather conditions.

Class of use: domestic.

BELANGRIJK, LEES DE INSTRUCTIES AANDACHTIG: BEWAAR DE GEBRUIKSAANWIJZING.

Doe-het-zelf installatie. Op een stabiele ondergrond plaatsen. Maximaal aanbevolen belasting: 100kg. Controleer of de vergrendelingen goed zijn bevestigd alvorens te gaan zitten. Controleer regelmatig de bevestigingspunten.

Wij zijn niet verantwoordelijk in geval van onjuist gebruik, verkeerde montage of bij noodweer.

Gebruiksclassificatie: huishoudelijk.

IMPORTANTE, GUARDE ESTE MANUAL COMO REFERENCIA FUTURA: LEA DETENIDAMENTE LAS INSTRUCCIONES.

Artículo para montar uno mismo. Colocar de manera estable sobre un suelo plano. Carga máxima aconsejada:

100kg. Comprobar que las fijaciones están colocadas antes de sentarse. Comprobar regularmente las fijaciones. Se declina toda responsabilidad en caso de utilización incorrecta, defecto de montaje o intemperie.

Clase de utilización: doméstico.

IMPORTANTE: GUARDE O MANUAL PARA FUTURAS REFERÊNCIAS: LEIA ATENTAMENTE ESTAS INSTRUÇÕES.

A ser montado pelo utilizador. Coloque de modo estável numa superfície plana. Carga máxima aconselhada:

100kg. Certifique-se de que as fixações estão devidamente colocadas antes de se sentar. Verifique regularmente as fixações. Não nos responsabilizamos no caso de má utilização, defeito de montagem ou intempéries.

Classe de utilização: doméstico.

WICHTIG – ANLEITUNG FÜR KÜNFTIGE BEZUGNAHME AUFBEWAHREN: BITTE LESEN SIE DIE ANWEISUNGEN SORGFÄLTIG DURCH.

Zur Selbstmontage. Stellen Sie es stabil auf ebenem Boden auf. Maximale empfohlene Last: 100kg. Vor dem

Hinsetzen sicherstellen, dass die Befestigungselemente ordnungsgemäß angebracht sind. Überprüfen Sie die Befestigungselemente regelmäßig. Wir lehnen jede Verantwortung im Falle von Missbrauch, Montagefehlern oder schlechtem Wetter ab.

Nutzungsklasse: Haushalt.



Ref:435717,435807,435855,435887,435929,435950,435992,437121,437188,442023,533300,533340,533339

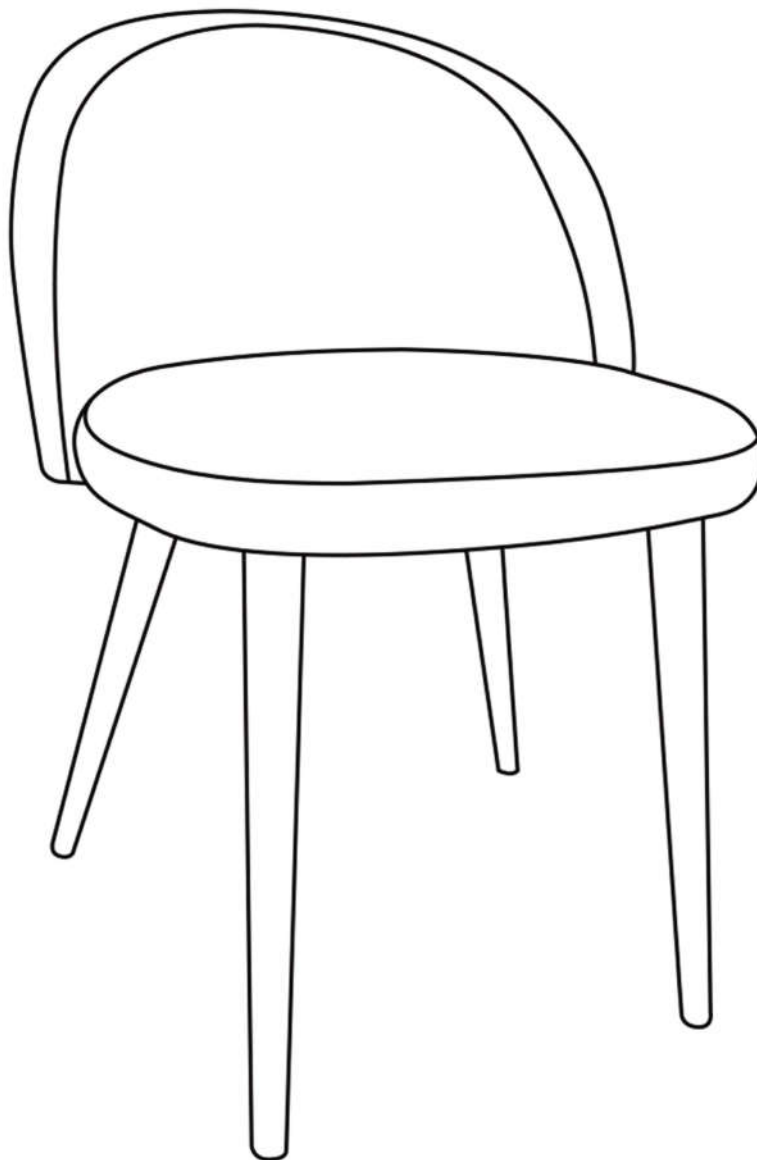
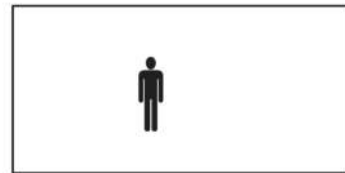
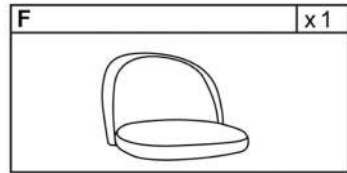
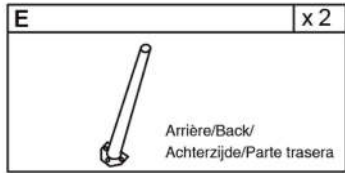
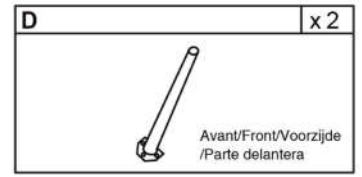
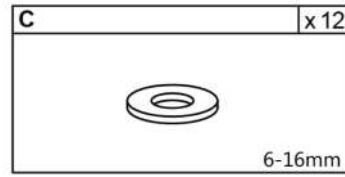
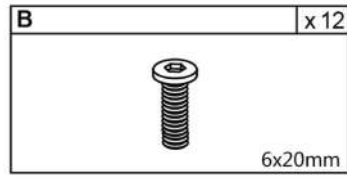
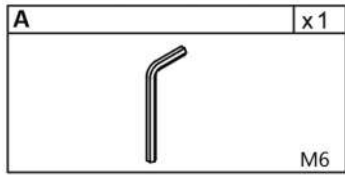

Ref:435717,435807,435855,435887,435929,435950,435992,437121,437188,442023,533300,533340,533339

1

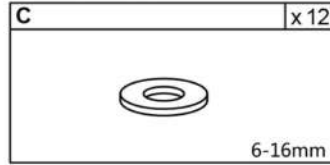
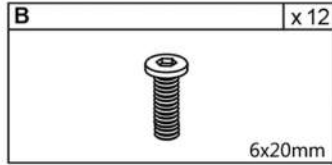
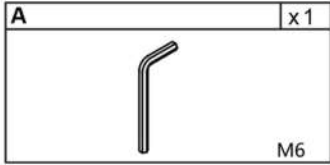
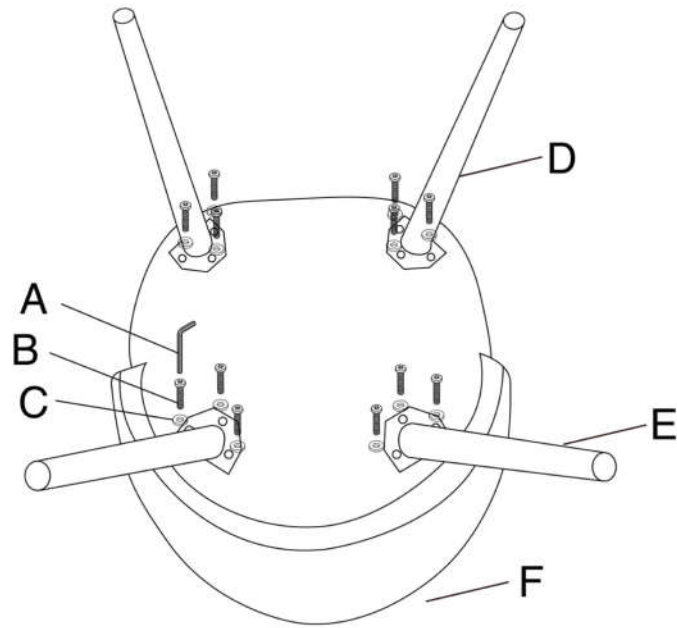

2

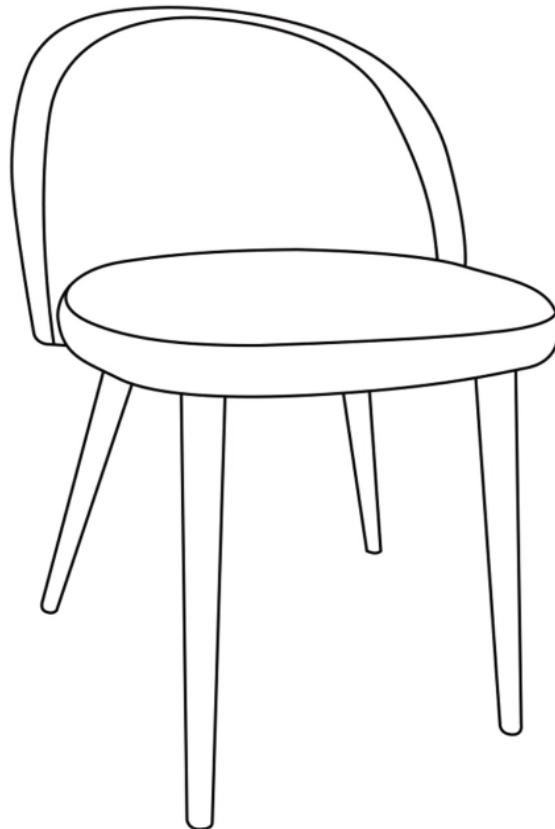

Ref:435717,435807,435855,435887,435929,435950,435992,437121,437188,442023,533300,533340,533339

